

INSTRUCTION

FRESH WATER STATION ECO 25

INSTALLATION AND OPERATING INSTRUCTIONS
PLEASE READ BEFORE INSTALLATION!



VERSION 04/2025

Table of contents

Safety instructions	3
1. Fresh water station eco 25	6
1.1 Technical specifications	7
1.2 Circuit diagram	9
1.3 Schematic	10
1.4 Dimensions for wall mounting	11
2. Assembly and installation	12
2.1 Assembly	12
2.2 Installation	13
3. Commissioning	14
3.1 Checking the installation	14
3.2 Filling the primary circuit	14
3.3 Filling the secondary circuit	14
3.4 Commissioning the controller	14
3.5 Checking the water heating	14
3.6 Completing commissioning	14
3.7 Handing over the system to the operator	14
3.8 For the operator	14
3.9 Operation	14
4. Resistance table	15

Safety instructions

These instructions are part of the product and contain basic instructions and important information on safety, installation, commissioning, maintenance and optimum use of the appliance.

- Read carefully before use.
- Store during the service life of the product.
- Make it accessible to operating, maintenance and service personnel at all times..
- Pass this on to any subsequent owner, operator or user.

Please also observe the accident prevention regulations applicable in the respective countries, the relevant standards and regulations and the installation and operating instructions for the additional system components. Installation, electrical connection, commissioning and maintenance of the device may only be carried out by a qualified specialist.

For the operator: Have a technician give you detailed instructions on how the controller works and how to operate it. Always keep these instructions near the controller.



Attention

For further information on commissioning and using the system, please refer to the enclosed operating instructions „Fresh water Controller SFWC“.

Symbols

Warnings are used in these instructions to warn against damage to property and personal injury.



Danger

Failure to observe these instructions may result in life-threatening effects due to electrical voltage.



Danger

Failure to observe these instructions can result in serious health consequences such as scalds and even life-threatening injuries.



Attention

Failure to observe these instructions may result in the destruction of the appliance, the system or environmental damage.



Attention

Information that is particularly important for the function and optimum use of the appliance and the system.

Intended use

- The fresh water station should only be used in combination with a buffer tank for heating drinking water in closed heating systems.
- Follow all instructions in this manual and the applicable documents.
- Observe maximum operating limits: see technical data for the respective station, page 12 and 13 see 5.2 Installation

Any use beyond this is considered improper. The manufacturer is not liable for any damage resulting from this. The user bears the sole risk for this.

Improper use

Any use other than that specified in these instructions and in the accompanying documents is considered improper. The manufacturer is not liable for any damage resulting from such use. The user bears sole responsibility for this risk.

- Do not connect the fresh water station directly to a heat generator (e.g., boiler or solar circuit).
- Do not use the fresh water station in the following areas: outdoors; damp rooms; rooms where the use of electrical appliances is prohibited; rooms at risk of frost.

Safety instructions

Personnel qualification

The fresh water station may only be installed, maintained and repaired by authorized, trained specialists

- Only use qualified personnel who, based on their training and experience, are capable of recognizing risks and avoiding potential hazards.
- Define the responsibilities of personnel according to their qualifications and job descriptions.
- Ensure that the following requirements are met:
 - The personnel have read and understood these operating instructions.
 - The personnel have received instruction on the hazards that may arise.
 - The personnel are familiar with and observe the relevant accident prevention and safety regulations.

Security measures

Materials and components used on site must be fully suitable for the intended purpose, tested or approved by the manufacturer and must meet the applicable laws, standards, guidelines and regulations.

- Only use appropriate materials and components.
- Do not make any unauthorized changes to the fresh water station.
- The controller of the fresh water station and the pumps are powered by electricity.
- Disconnect the system from the power supply before starting maintenance, servicing and repair work and secure it against being switched back on.
- Keep your workplace clean and free of obstructions.
- Make sure there is sufficient lighting.
- Keep children, pets and unauthorized persons away from tools and assembly areas.
- Store hazardous substances and liquids safely and away from the station area.
- Work on the system should only be carried out by a qualified technician.

During operation

- If damage occurs to the system:
 - Take the system out of operation.
 - Do not continue to operate the system.

During maintenance and repair

- Never allow the operator to remove the EPP cover or carry out repairs.
- Only allow repairs to be carried out by a specialist.
- Only use original spare parts.

Fire protection

- Observe applicable fire protection regulations and valid building codes/building regulations. This applies in particular in the following cases:
 - When penetrating ceilings and walls.
 - In rooms with special/stricter requirements for preventive fire protection measures.

Residual risks

Water quality

- Take corrosion protection and scale formation into account in planning in accordance with DIN 1988-7 and drinking water analyses (in accordance with DIN 50930 part 6).
- Check regularly in accordance with DIN 1988.



Attention

Station failure due to calcified heat exchanger!

To minimize calcification of the heat exchanger, we recommend installing a water softener at a hardness level of **14°dH** or higher.



Attention

Please refer to the compatibility table on page 15

Safety instructions

Prevention of property damage

On-site heating system

- Flush on-site heating systems thoroughly before installing the station.

Safety equipment in the primary circuit

- Observe VDI guideline 2035 (sheet 1 and 2) during planning, installation and operation.
- Plan and install a safety valve in the primary circuit.

Safety equipment in the secondary circuit

- Provide a drain pipe for the secondary circuit in accordance with DIN 1988.
- Plan and install a safety valve in the secondary circuit.

Damage to pumps caused by magnetite deposits

- Please install a magnetite separator.

Repairs

- Repairs should only be carried out by a qualified technician.
- Only use original replacement parts.

1. Fresh water station eco 25

Description Fresh water station

Application

The eco 25 fresh water station is ideal for the central heating of drinking water in heating systems. The heating water is taken from the buffer tank and passed through the plate heat exchanger to heat the drinking water directly as required. A buffer tank is required to ensure the necessary heating water flow rate. **There is no storage of drinking water!**

Hot water preparation

The eco 25 heats drinking water only "**Just in time**" i.e., only when it is actually needed. This reduces energy costs and eliminates unnecessary hot water storage.

High-efficiency pump

Eine **Hocheffizienzpumpe** fördert den, für die Erwärmung notwendigen, Heizwasservolumenstrom drehzahlregelt vom Pufferspeicher zum Plattentaucher

Control function

The central control unit is the **electronic control system**. This ensures a constant domestic hot water temperature.

Sensors

Fast and highly accurate control processes are made possible by the use of state-of-the-art sensors. A **flow sensor based on the vortex principle** determines the flow rate and hot water temperature.

Housing

Elegant EPP insulated housing, designer front, with sturdy instrument panel made of galvanized sheet steel, all drinking water outlets facing upwards.



1.1 Technical specifications

	PRIMARY BUFFER STORAGE	SECONDARY DRINKING WATER
Pressure rating:	PN 6	PN 10
Max. temperature:	110 °C	75 °C
Connection dimensions:	DN 20	DN 20
Thread:	G $\frac{3}{4}$ " ÜWM	G $\frac{3}{4}$ " ÜWM
Connections:	HV + HR downwards, KW + TWW on the right side	
Electrical connection:	230 V Schuko plug	
Electrical power:	max. 50 Watts connected load	
Dimensions (WxHxD):	285 x 365 x 138 mm	
Weight:	7,2 kg	

PERFORMANCE DATA	PI2*	PI1**
Hot water output:	70 kW	61 kW
Primary flow rate:	1597 kg/h (27,3 l/min)	1424 kg/h (24,2 l/min)
Supply temperatures:	70 °C	60 °C
Return temperatures:	32 °C	23 °C
CW/HW temperature:	10 °C / 60 °C	10 °C / 45 °C
Flow rate:	20 l/min	25 l/min

! **Attention!** Normal operation guaranteed at 50-75 C, install a pre-mixer if necessary

***PI 2 = Performance indicator 2**

at a set hot water temperature of 60°C

at a primary flow temperature of 70°C

at a cold water temperature of 10°C

****PI 1 = Performance indicator 1**

at a set hot water temperature of 45°C

at a primary flow temperature of 60°C

at a cold water temperature of 10°C

ORDER NO.

1630007 with fully stainless steel brazed plate heat exchanger

1630008 with copper-brazed plate heat exchanger

1.1 Technical specifications

Pressure loss on drinking water side eco 25 (secondary)

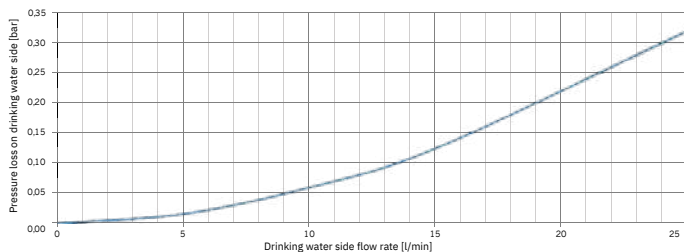

Pressure loss on heating side and pump characteristic curve eco 25 (primary)

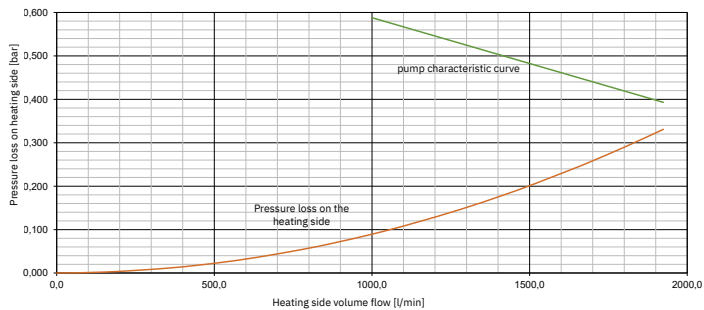

Volume flow on the primary side at different supply temperatures for domestic hot water heating

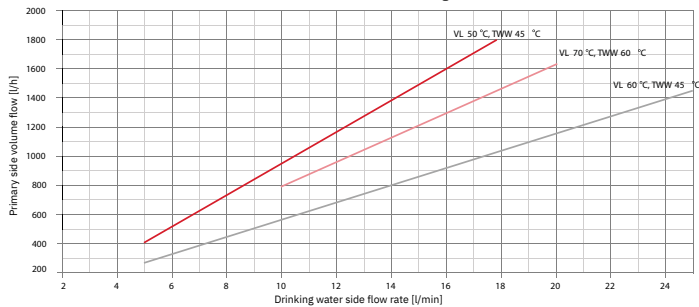

Return temperature on the primary side at different flow temperatures for domestic hot water heating (from 10 °C cold water)

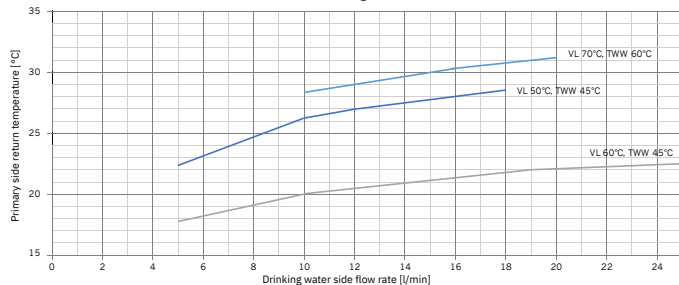

1.2 Circuit diagram

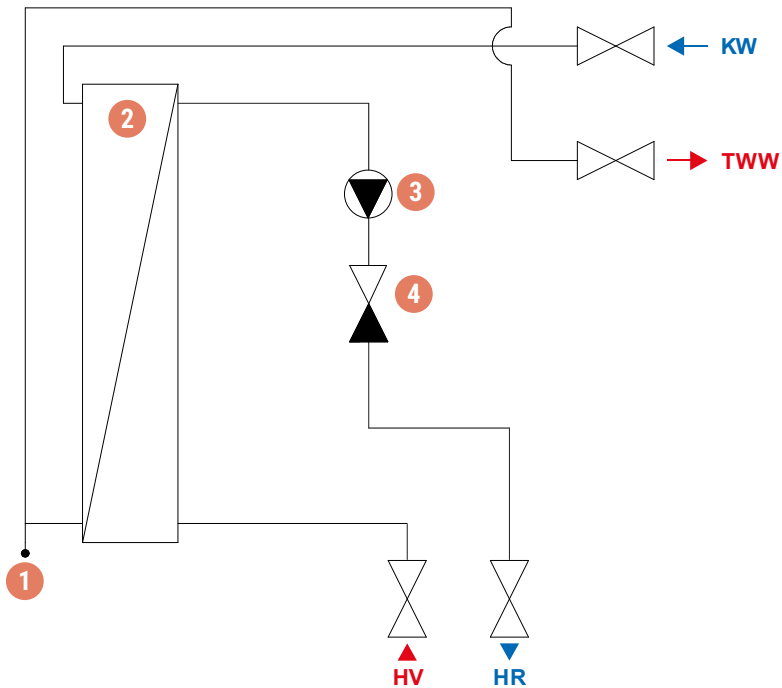

CIRCUIT DIAGRAM

1	Vortex sensor DHW + flow	TWW	Hot drinking water
2	Plate heat exchanger	KW	Cold water
3	Heating pump	HV	Heating Supply
4	Backflow preventer	HR	Heating Return

1.3 Schematic

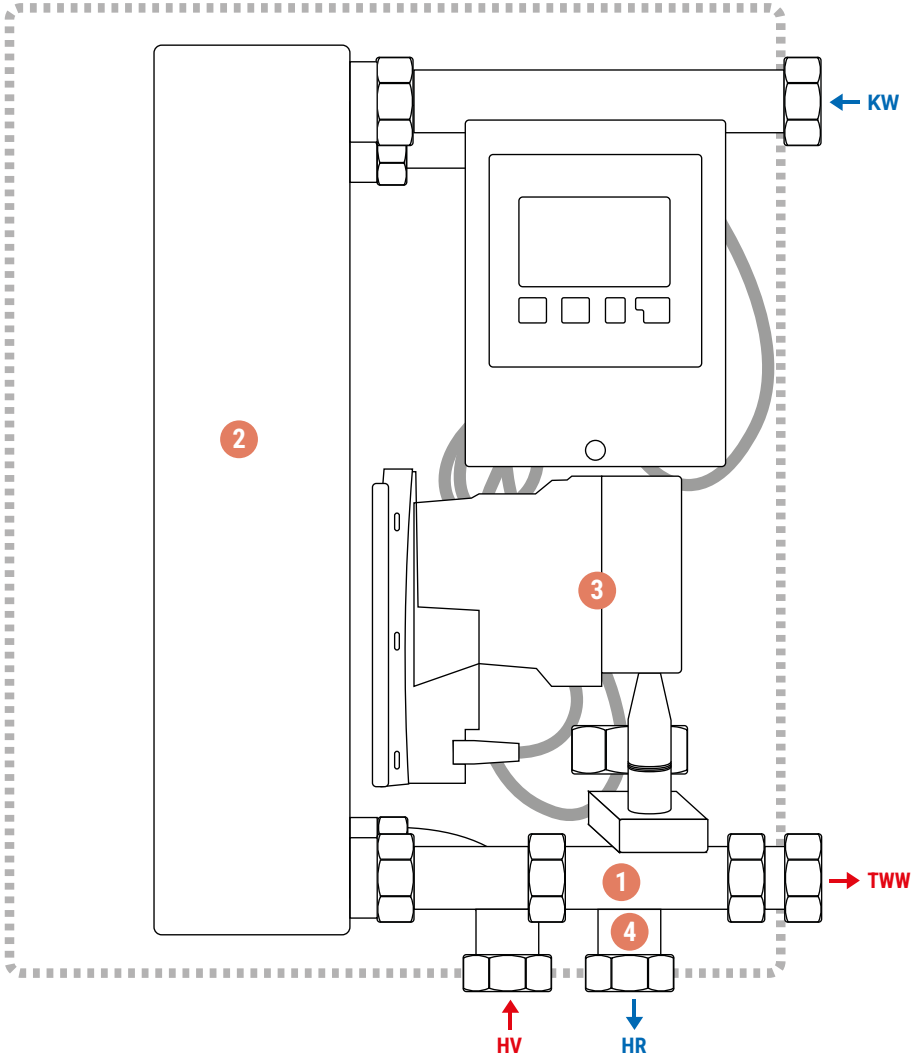

1.4 Dimensions for wall mounting

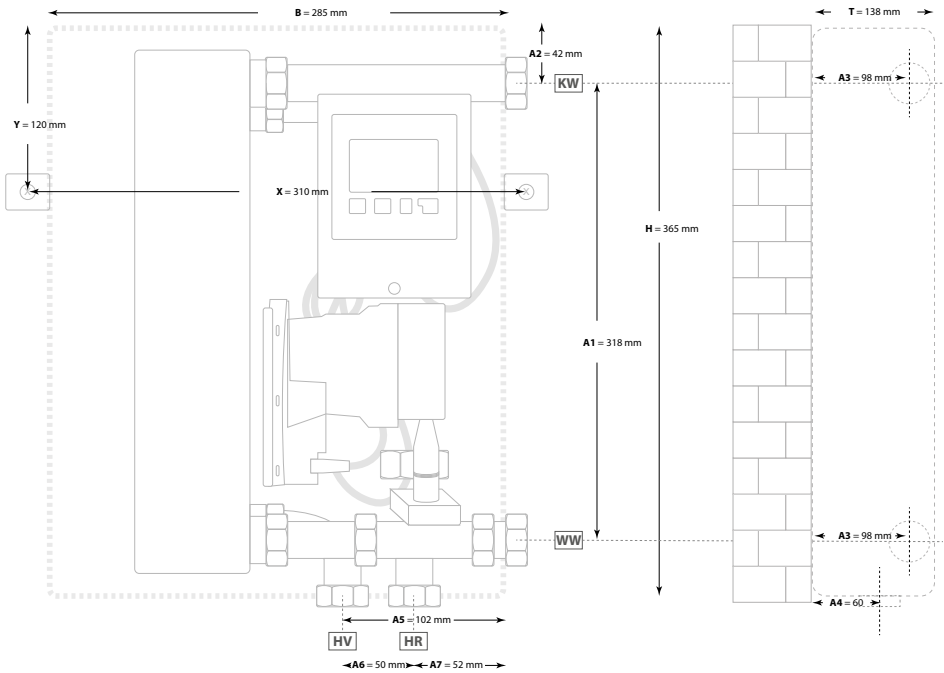

DIMENSION TABLE

Width B:	285 mm
Height H:	365 mm
Depth T:	138 mm
X = Distance between drill holes	310 mm
Y = Distance between drill holes and upper edge	120 mm
A1 = Distance between pipe WW and KW	318 mm
A2 = Distance between pipe KW and upper edge	42 mm
A3 = Distance between wall and pipes WW/KW	98 mm
A4 = Distance between wall and pipes HV/HR	60 mm
A5 = Distance between pipe HV and right edge	102 mm
A6 = Distance between pipe HV and HR	50 mm
A7 = Distance between pipe HR and right edge	52 mm

2. Assembly and installation



Risk of electric shock

Disconnect the system from the power supply before starting maintenance, servicing and repair work and secure it against being switched back on.



To prevent damage to the system, the installation site must be dry, stable and frost-free.

2.1 Assembly

After removing the transport packaging, slide the mounting rail from the RIGHT into the side slot until it comes out on the other side. Use the supplied mounting hardware to attach the station to the desired location.

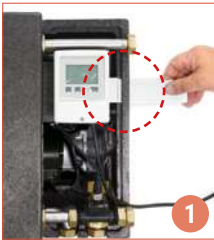

1 Install the mounting rail from the RIGHT.



2 Carefully remove both halves of the cover.



3 Remove the transport lock.



4 Insert the power cable into one of the two side inputs.



5 Install the heating connections and drinking water connections and flush the station.



6 Reattach both halves of the lid.



7 Connect the station to the power supply.



8 Check the settings or adjust them if necessary.

2. Assembly and installation

2.2 Installation

Pipe the fresh water station to the system as shown in the figures on page 9.

- 1. Primary side return:**
Return to buffer tank, G $\frac{3}{4}$ " ÜWM connection,
piping at least DN 20, 22 x 1 mm,
maximum length 2 m.
- 2. Primary side supply:**
Supply to buffer tank, G $\frac{3}{4}$ " ÜWM connection,
piping at least DN 20, 22 x 1 mm,
maximum length 2 m.
- 3. Secondary side DHW:**
Hot water outlet, G $\frac{3}{4}$ " ÜWM connection.
- 4. Secondary side CW:**
Cold water inlet, G $\frac{3}{4}$ " ÜWM connection.



Attention

Damage to pumps due to dry running!

Ensure that the piping is tight.
Ensure that the pump is filled correctly.



Attention

Damage to pumps due to overpressure!

After completing installation, secure fittings with seals to prevent accidental closure.

3. Commissioning

3.1 Checking the installation

1. Completeness of the piping of the fresh water station.
2. Piping for leaks.
3. Correct installation of safety-related components. (see safety instructions page 6)

3.2 Filling the primary circuit

1. Observe the non-return valve in the storage tank return.
2. Fill and flush the primary circuit.
3. Fill and vent the buffer tank.
4. Vent the primary circuit at the pump, pipes and buffer tank.

3.3 Filling the secondary circuit

1. Fill and vent the secondary circuit.



Note: Fill slowly and avoid water hammer during filling, as this can damage the vortex sensor.

2. Vent the fresh water station by tapping (cold and hot water side).

3.4 Commissioning the controller

1. Connect the controller (according to the external instructions for the fresh water controller SFWC).
2. Do not close the shut-off valves between the fresh water station and the safety valves while the primary circuit pump is in operation.
3. Start up the controller (the controller is partially preset at the factory).
4. To change the settings, follow the external instructions for the controller.

3.5 Checking the water heating

1. Tap hot water.
2. Check water heating.

3.6 Completing commissioning

1. Clean the inside of the fresh water station of any construction dirt.
2. Put the cover on.
3. Clean the outside of the system of any construction dirt.

3.7 Handing over the system to the operator

1. Instruct the operator of the system in how to operate the system (in accordance with the operating instructions for the controller). Point out safety and maintenance intervals.
2. Note the parameters set during transfer in the protocol.
3. Pass on all instructions to operators:
 - These installation and operating instructions
 - Operating instructions for SFWC fresh water controller

3.8 For the operator

Attach all instructions at the installation site of the fresh water station or keep them near the fresh water station.

3.9 Operation

Operate the system according to external instructions for controllers.

4. Resistance table

The following guide is intended to provide an overview of the corrosion resistance of stainless steels and brazing materials in tap water at room temperature. The table lists several important chemical components, but actual corrosion is a very complex process that is influenced by many different components in combination with each other.

This table is therefore a considerable simplification and should not be overrated!

Explanations:

- + = Good resistance under normal conditions
- 0 = Corrosion may occur, especially if other factors are rated 0
- = Use not recommended

WATER CONTENT	CONCENTRATION (mg/l or ppm)	TIME LIMITS *	STAINL. STEEL AISI 316	STANDARD PLATE HEAT EXCHANGER **	SPECIAL PLATE HEAT EXCHANGER ***
Alkalinity (HCO ₃ ⁻)	< 70	Within 24 hours	+	0	+
	70-300		+	+	+
	> 300		+	0/+	+
Sulfate (SO ₄ ²⁻)	< 70	No limit	+	+	+
	70-300		+	0/-	+
	> 300		+	+	+
HCO ₃ ⁻ / SO ₄ ²⁻	> 1,0	No limit	+	+	+
	< 1,0		+	0/-	+
Electrical conductivity	< 10 µS/cm	No limit	+	0	+
	70 - 300 µS/cm		+	+	+
	300 - 500 µS/cm		+	0	+
	> 500 µS/cm		+	-	+
pH ^[2]	< 6,0	Within 24 hours	0	0	+
	6,0 - 7,5		+	0	+
	7,5 - 9,0		+	+	+
	> 9,0		+	0	+
Ammonium (NH ₄ ⁺)	< 2	Within 24 hours	+	+	+
	2 - 20		+	0	+
	> 20		+	-	+
Chloride (Cl ₂)	< 100	No limit	+	+	+
	100 - 200		+	+	+
	200 - 300		+	+	+
	> 300		-	0/+	+
Free chlorine (Cl ₂)	< 1	Within 5 hours	+	+	+
	1 - 5		-	0	+
	> 5		-	0/-	+
Hydrogen sulfide (H ₂ S)	< 0,05	No limit	+	+	+
	> 0,05		+	0/-	+
Free (aggressive) carbon dioxide (CO ₂)	< 5	No limit	+	+	+
	5 - 20		+	0	+
	> 20		+	-	+
Total hardness (°dH)	4,0 - 8,5	No limit	+	+	+
Nitrate ^[1] (NO ₃ ⁻)	< 100	No limit	+	+	+
	> 100		+	0	+
Iron ^[3] (Fe)	< 0,2	No limit	+	+	+
	> 0,2		+	0	+
Aluminium (Al)	< 0,2	No limit	+	+	+
	> 0,2		+	0	+
Manganese ^[3] (Mn)	< 0,1	No limit	+	+	+
	> 0,1		+	0	+

^[1] Sulfates and nitrates act as inhibitors for pitting corrosion caused by chlorides in pH-neutral environments.

^[2] In general, a low pH value (below 6) increases the risk of corrosion, while a high pH value (above 7.5) reduces the risk of corrosion.

^[3] Fe³⁺ and Mn²⁺ are strong oxidizing agents and can increase the risk of local corrosion in stainless steels.

SiO₂ above 150 ppm increases the risk of calcification.

* Examination time after sample collection

** Standard plate heat exchanger data refers to copper solder joints

*** Special plate heat exchanger data refers to copper-free solder joints

Strasshofer GmbH

Am Fernblick 11
08499 Reichenbach
Germany

Phone: +49 3765 3804 30
E-Mail: info@strasshofer.de

Presented by:

