

INSTRUCTION

BE - FLAT HIU STATIONS WITH REHEATING

INSTALLATION AND OPERATING INSTRUCTIONS
PLEASE READ BEFORE INSTALLATION!



STAND 04/2026

Table of contents

Safety instructions	3
Sample Commissioning Report	5
1. Flat HIU stations for decentralized DHW heating	6
All stations at a glance / Functions and optional modules	6
BE-TNE	8
BE-HNE	10
BE-FNE	12
2. Installation	14
2.1 Installation: The example of a flush-mounted cabinet	14
2.2 Making electrical connections	15
2.3 Completing the installation	16
3. Commissioning	17
3.1 Checking the station before commissioning	17
3.2 Filling & Rinsing	18
3.3 Venting	19
3.4 Refilling the heating system	19
4. Settings.	20
4.1 Preset volume flow for the underfloor heating circuit with VA-FBif	20
4.2 Setting Module D1 - Differential pressure regulator	20
4.2 Settings for the Module VA-FBif	21
4.3 HCC-Fresh Controller Wiring Diagram	22
4.4 Wiring Diagram with Base station and Actuator	23
5. Modules	24
5.1 Module S1 - Strainer insert	24
5.2 Module ZV - Zone valve	24
5.3 Module VOR - Priority circuit	25
5.4 Module VR - Volume flow controller	25
5.5 Module D2 - Differential pressure regulator	26
5.6 Other available Modules	27
6. Additional information	28
7. Malfunction / Causes / Remedy	28
8. Resistance table	29
9. Commissioning certificate / Certificate of guarantee	31

Safety instructions

These instructions are part of the product and contain basic instructions and important information on safety, installation, commissioning, maintenance and optimum use of the appliance.

- Read carefully before use.
- Store during the service life of the product.
- Make it accessible to operating, maintenance and service personnel at all times.
- Pass this on to any subsequent owner, operator or user.

Please also observe the accident prevention regulations applicable in the respective countries, the relevant standards and regulations and the installation and operating instructions for the additional system components. Installation, electrical connection, commissioning and maintenance of the device may only be carried out by a qualified specialist.

For the operator: Have a technician give you detailed instructions on how the controller works and how to operate it. Always keep these instructions near the controller.

Symbols

Warnings are used in these instructions to warn against damage to property and personal injury.



Failure to observe these instructions may result in life-threatening effects due to electrical voltage.



Failure to observe these instructions can result in serious health consequences such as scalds and even life-threatening injuries.



Failure to observe these instructions may result in the destruction of the appliance, the system or environmental damage.



Information that is particularly important for the function and optimum use of the appliance and the system.

Intended use

- Only use the flat HIU/CIU stations in combination with a buffer storage for heating domestic hot water in closed heating systems.
- Observe all instructions in this manual and the applicable documents.
- Observe the maximum application limits: see technical data of the respective station.

Any other use is considered improper use. The manufacturer is not liable for any resulting damage. The user alone bears the risk.

Improper use

Any uses other than those described in these instructions and in the applicable documents are improper. The manufacturer is not liable for any resulting damage. The user alone bears the risk.

- Do not connect the flat HIU/CIU stations directly to a heat generator (e.g. boiler or solar circuit).
- Do not use the flat HIU/CIU stations in the following areas: outdoor areas; damp rooms; rooms in which the use of electrical appliances is prohibited; rooms threatened by frost.

Personnel qualification

The flat HIU/CIU stations may only be installed, maintained and repaired by authorized and trained specialists.

- Only deploy skilled personnel whose training and experience enable them to recognize risks and avoid potential hazards.
- Define the responsibilities of staff according to their qualifications and job description.
- Ensure that the following requirements are met:
 - The personnel have read and understood these operating instructions.
 - The personnel have received instruction on the hazards involved.
 - The personnel know and observe the relevant accident prevention regulations as well as the safety regulations.

Safety instructions

Security measures

Materials and components used on site must be fully suitable for the intended purpose, tested or approved by the manufacturer and must meet the applicable laws, standards, guidelines and regulations.

- Only use appropriate materials and components.
- Do not make any unauthorized changes to the flat HIU station.
- The controller of the flat HIU station and the pumps are powered by electricity.
- Disconnect the system from the power supply before starting maintenance, servicing and repair work and secure it against being switched back on.
- Keep your workplace clean and free of obstructions.
- Make sure there is sufficient lighting.
- Keep children, pets and unauthorized persons away from tools and assembly areas.
- Store hazardous substances and liquids safely and away from the station area.
- Work on the system should only be carried out by a qualified technician.

During operation

- If damage occurs to the system:
 - Take the system out of operation.
 - Do not continue to operate the system.

During maintenance and repair

- Never allow the operator to remove the EPP cover or carry out repairs.
- Only allow repairs to be carried out by a specialist.
- Only use original spare parts.

Fire protection

- Observe applicable fire protection regulations and valid building codes/building regulations. This applies in particular in the following cases:
 - When penetrating ceilings and walls.
 - In rooms with special/stricter requirements for preventive fire protection measures.

Residual risks

Water quality

- Take into account corrosion protection and scale formation in the design in accordance with DIN 1988-7 drinking water analyses (in accordance with DIN 50930 Part 6).
- Test regularly in accordance with DIN 1988



Attention

Please refer to the resistance table on page 29

Prevention of property damage

On-site heating system

- Flush on-site heating systems thoroughly before installing the station.

Safety equipment in the primary circuit

- Observe VDI guideline 2035 (sheet 1 and 2) during planning, installation and operation.
- Plan and install a safety valve in the primary circuit.

Repairs

- Repairs should only be carried out by a qualified technician.
- Only use original replacement parts.

Example commissioning certificate

COMMISSIONING CERTIFICATE / CERTIFICATE OF GUARANTEE

BUILDING PROJECT	APARTMENT
Name: Sample complex	Floor: 3rd floor / apt. 5 / left
Street: Any street 12	Street: Any street 12
City: 80000 Munich	City: 80000 Munich
Project: Sample complex	Phone: +49 123 456789
Order: 12-X501	Email: info@sample-complex.com
Date: June 22, 2021	

PRODUCT				
Type:	BM-F	FM	SM	M
Serial number:	12345ZX	flush-mounted	surface-mounted	XL
Manufacturing date:	June 22, 2021			
Number of radiator circuits:	1			
Number of floor circuits:	10			
Test date:	June 29, 2021	Tester:	John Doe	

To be completed by the customer

COMMISSIONING BY (INSTALLER)	COMMISSIONING CHECKLISTE
Name: Heating engineers Ltd.	Checking before commissioning: X
Street: Other street 46	Purging: X
City: 80212 Munich	Filing: X
Phone: +49 987 654321	Venting: X
Email: info@heating-engineers.com	Check setting values: X
	Completed acceptance report: X
	Installed thermostatic sanitary fittings? YES X NO
	Removed hot water limitation for sanitary fittings? YES X NO

MEASURED VALUES					
Primary supply temperature:	60	°C	Temperature maintenance valve:	40.0	°C
Primary return temperature:	17 +/-	°C	Sec. differential pressure (module D2):	255	mbar
Hot water temperature:	45	°C	Floor heating supply temperature:	30	°C
Hot water amount:	21.0	l/min			
Primary volume flow for DHW heating:	960	l/h			

IMPORTANT - PLEASE NOTE!

Commissioning has been carried out correctly.

Please send us the **duly completed acceptance report by email after commissioning**. Only then we can guarantee you adequate support or customer service.

June 29, 2021

Commissioning date

SAMPLE COMPLEX MUNICH

A. Sample

Customer signature / stamp

email to: see back of instruction

Heating engineers Ltd.

G. Raymond

Specialist installer signature / stamp

1. All stations at a glance / Functions and optional modules

Flat HIU stations Type BE with Reheating

Domestic hot water preparation

Domestic hot water is heated on-demand using the flow-through principle via a stainless steel plate heat exchanger and the integrated electric instantaneous water heater. A temperature and flow sensor based on the vortex principle measures the temperatures and flow rates. The controller regulates the required heating energy for the plate heat exchanger using a step a valve stepper motor valve. The plate heat exchanger is not kept warm. Unnecessary circulation loss is avoided, and increased Legionella growth is effectively prevented.

A universal 110 mm installation section for cold water meters and a universal 110 mm installation section for heat meters up to 1,5 Qn are integrated into the EPP insulation box.

- † **step a valve stepper motor valve:** Precise control of hot water preparation using the flow principle. Minimizes energy losses and prevents the formation of Legionella bacteria.
- † **Electronic instantaneous water heater:** Reheating with precise temperature control from 20-60 °C.
- † **Energy efficient:** Operation with low heating flow temperatures (35 - 40°C), optimized for heat pumps with a high COP value for maximum efficiency.
- † **EPP insulated box:** With excellent thermal insulation for energy-saving operation and reliable protection.
- † **Protection and comfort:** Includes drinking water priority circuit and water hammer damper for a secure water supply.
- † **Insulated cold water pipes:** Prevents heat transfer and increases energy efficiency.
- † **Stainless steel piping:** Robust, corrosion-resistant pipes (18x1 mm).
- † **Low-profile design:** Compact depth of 130 mm.
- † **Differential pressure regulator:** Stabilizes differential pressure in primary circuit and ensures constant flow control.

CONTROLLER	END CUSTOMER MENU (SIMPLE)	TECHNICIAN MENU (EXPERT)
DISPLAY	Time & date	Measured values or hydraulic diagram
SETTINGS	<ul style="list-style-type: none"> • Time & date • Daylight saving time • Night setback time for standby 	<ul style="list-style-type: none"> • Hot water temperature • Maintenance temperature station • Commissioning assistant

1. All stations at a glance / Functions and optional modules

Technical Data

TECHNICAL DATA - FLAT HIU STATION

	HEATING PRIMARY	HEATING SECONDARY	
	BUFFER STORAGE	UF-HEATING	DRINKING WATER
Pressure rate:	PN 6	PN 6	PN 10
Max. temperature:	90 °C	60 °C	75 °C
Connection dimensions:	DN 25	DN 20	DN 20
Thread:	G1" internal	G¾" internal	G¾" internal

TECHNICAL DATA - INSTANTANEOUS WATER HEATER, 13 KW (EXAMPLE)

	PREHEATING	E-REHEATING	MIXING TEMPERATURE	
	Supply primary:	38 °C	-	-
Heating volume flow:	1250 l/h	-	-	
Power:	24,1 kW	13,5 kW	-	
DHW:	15,0 l/min	10,0 l/min	15,0 l/min	18,7 l/min
DHW temperature:	33 °C	52 °C	45 °C	38 °C
DW temperature:	10 °C	33 °C	-	
Total power:	-	-	37,6 kW	
Pressure level heating/sanitary:	PN 6 / PN 10			
Max. heating temperature:	90 °C			
Electrical connection for electric IWH:	3 ~/ PE 400 V AC 20 A, 13,5 kW			
Minimum cable cross-section:	2,5 mm ² at 13,5 kW			

Optional Modules & Accessories

		ORDER NO.	BE-TNE	BE-HNE	BE-FNE
Module S1	Strainer insert	1000100	<input checked="" type="checkbox"/>	<input checked="" type="checkbox"/>	<input checked="" type="checkbox"/>
Module VR	Volume flow controller	1000105	<input type="checkbox"/>	<input checked="" type="checkbox"/>	<input checked="" type="checkbox"/>
Module D2	Differential pressure regulator	1000117	<input type="checkbox"/>	<input checked="" type="checkbox"/>	<input checked="" type="checkbox"/>
Module ZV	Zone valve	1000120	<input type="checkbox"/>	<input checked="" type="checkbox"/>	<input checked="" type="checkbox"/>
Module VOR	Priority circuit	1000160	<input type="checkbox"/>	<input checked="" type="checkbox"/>	<input checked="" type="checkbox"/>
VA-FBif for 2-12 circuits	Floor heating manifold	3702BX-3712BX	<input type="checkbox"/>	<input type="checkbox"/>	<input checked="" type="checkbox"/>
eco-STA 230 V	Electrothermal actuator	1003L	<input type="checkbox"/>	<input type="checkbox"/>	<input checked="" type="checkbox"/>
TT-KL6 / TT-KL10	Base station	1011 / 1015	<input type="checkbox"/>	<input type="checkbox"/>	<input checked="" type="checkbox"/>

possible not possible

1.1 Flat HIU station BE-TNE



TECHNICAL DATA - FLAT HIU STATION

	HEATING PRIMARY	HEATING SECONDARY	
	BUFFER STORAGE	UF-HEATING	DRINKING WATER
Pressure rating:	PN 6	PN 6	PN 10
Max. temperature:	90 °C	60 °C	75 °C
Connection dimensions:	DN 25	DN 20	DN 20
Thread:	G1" internal	G¾" internal	G¾" internal
Size (WxHxD):	Flush-m.: 747 x 827 x 130-175 mm / Surface-m.: 880 x 900 x 140 mm		
Niche size (WxHxD):	Flush-m.: min. 757 x 837 x 135 mm		

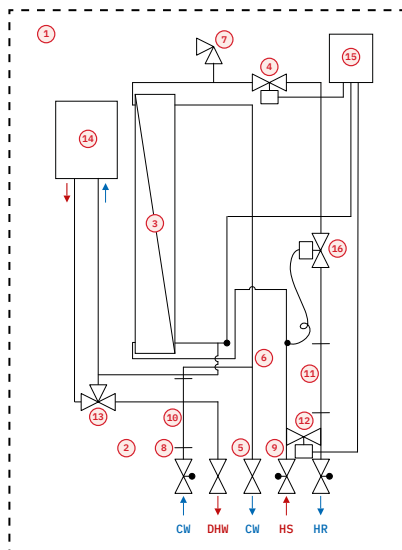

HYDRAULIC DIAGRAM

SCHEMATIC

- 1 Built-in cabinet
- 2 Connection rail with ball valves
- 3 Plate heat exchanger
- 4 step a valve stepper motor valve (Drinking water)
- 5 Cold water outlet
- 6 Cold water maximum limiter (optional)
- 7 Ventilation and drainage
- 8 Strainer insert CW (optional)
- 9 Strainer insert HS (optional)
- 10 Cold water meter fitting piece G¾" - 110 mm
- 11 Heat meter fitting piece G¾" - 110 mm
- 12 Temperature maintenance valve (bypass) with actuator
- 13 Hot water mixing valve
- 14 Reheater
- 15 Controller
- 16 Differential pressure regulator

- DHW** Domestic hot water
CW Cold water
HS Heating Supply primary
HR Heating Return primary

1.1 Flat HIU station BE-TNE

FLUSH-MOUNTED

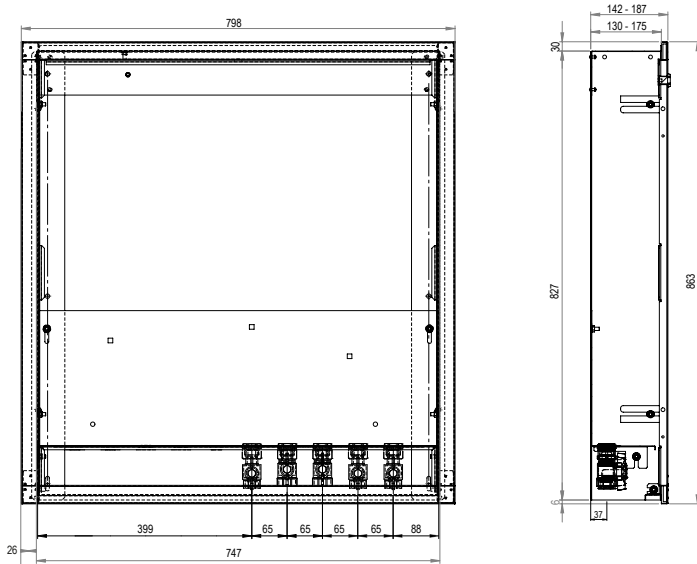

SURFACE-MOUNTED

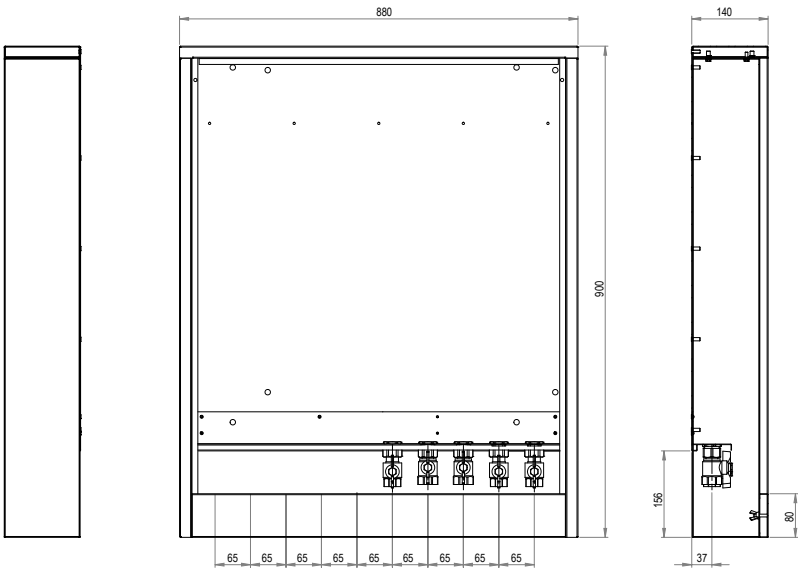

1.2 Flat HIU station BE-HNE



TECHNICAL DATA - FLAT HIU STATION

	HEATING PRIMARY	HEATING SECONDARY	
	BUFFER STORAGE	UF-HEATING	DRINKING WATER
Pressure rating:	PN 6	PN 6	PN 10
Max. temperature:	90 °C	60 °C	75 °C
Connection dimensions:	DN 25	DN 20	DN 20
Thread:	G1" internal	G¾" internal	G¾" internal
Size (WxHxD):	Flush-m.: 812 x 827 x 130-175 mm / Surface-m.: 880 x 900 x 140 mm		
Niche size (WxHxD):	Flush-m.: min. 822 x 837 x 135 mm		

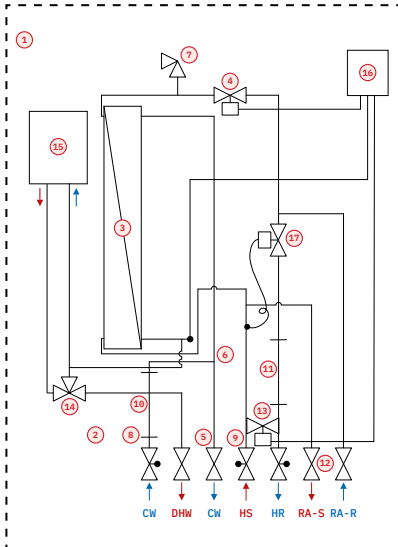

HYDRAULIC DIAGRAM

SCHEMATIC

- 1 Built-in cabinet
- 2 Connection rail with ball valves
- 3 Plate heat exchanger
- 4 step a valve stepper motor valve (Drinking water)
- 5 Cold water outlet
- 6 Cold water maximum limiter (optional)
- 7 Ventilation and drainage
- 8 Strainer insert CW (optional)
- 9 Strainer insert HS (optional)
- 10 Cold water meter fitting piece G¾" - 110 mm
- 11 Heat meter fitting piece G¾" - 110 mm
- 12 Radiator outlet
- 13 Differential pressure regulator
- 14 Hot water mixing valve
- 15 Reheater
- 16 Controller
- 17 Differential pressure regulator

- DHW** Domestic hot water
CW Cold water
HS Heating Supply primary
HR Heating Return primary
RA-S Radiator Supply
RA-R Radiator Return

1.2 Flat HIU station BE-HNE

FLUSH - MOUNTED

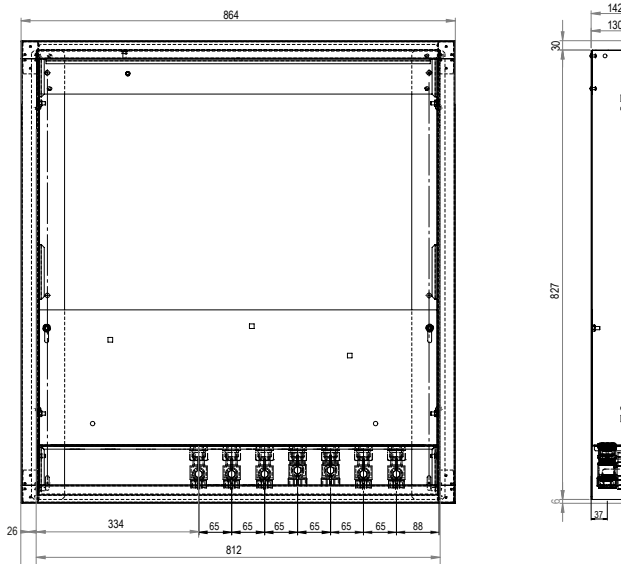

SURFACE - MOUNTED

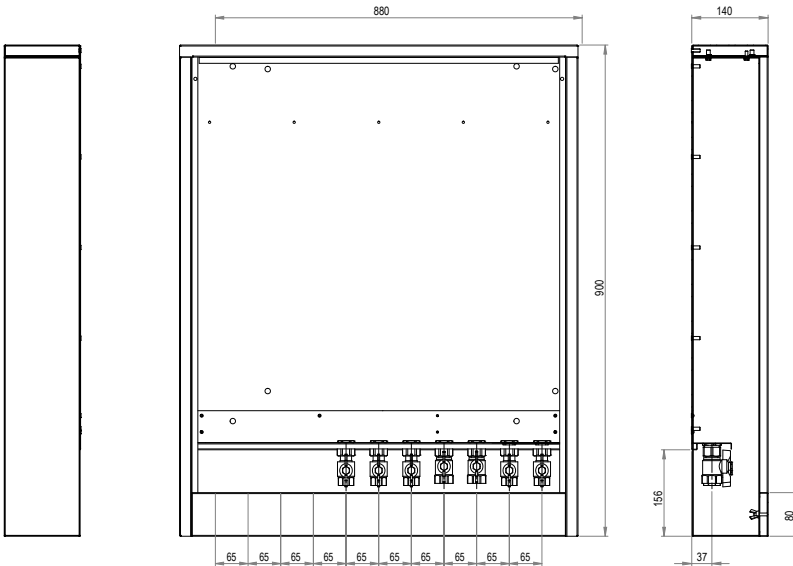

1.3 Flat HIU station BE-FNE



TECHNICAL DATA - FLAT HIU STATION

	HEATING PRIMARY	HEATING SECONDARY	
	BUFFER STORAGE	UF-HEATING	DRINKING WATER
Pressure rating:	PN 6	PN 6	PN 10
Max. temperature:	90 °C	60 °C	75 °C
Connection dimensions:	DN 25	DN 20	DN 20
Thread:	G1" internal	G¾" internal	G¾" internal
Size (WxHxD):	Flush-m.: 812 x 1298-1470 x 130-175 mm / Surface-m.: 880 x 1400 x 140 mm		
Niche size (WxHxD):	Flush-m.: min. 822 x 1308-1480 x 135 mm		

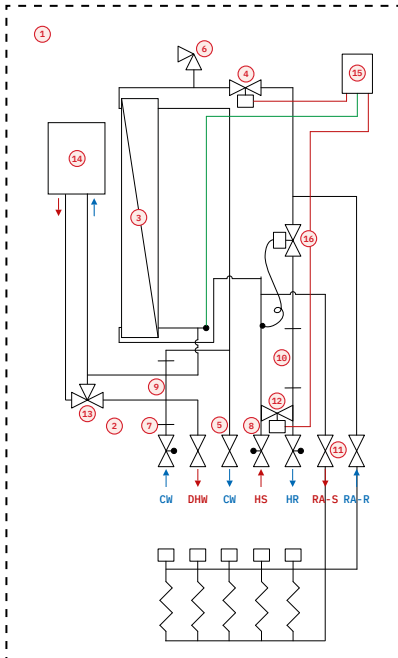

HYDRAULIC DIAGRAM

SCHEMATIC

- 1 Built-in cabinet
- 2 Connection rail with ball valves
- 3 Plate heat exchanger
- 4 step a valve stepper motor valve (Drinking water)
- 5 Cold water outlet
- 6 Ventilation and drainage
- 7 Strainer insert CW (optional)
- 8 Strainer insert HS (optional)
- 9 Cold water meter fitting piece G¾" - 110 mm
- 10 Heat meter fitting piece G¾" - 110 mm
- 11 Floor heating outlet
- 12 Temperature maintenance valve (bypass) with actuator
- 13 Hot water mixing valve
- 14 Reheater
- 15 Controller
- 16 Differential pressure regulator

- DHW** Domestic hot water
CW Cold water
HS Heating Supply primary
HR Heating Return primary
RA-S Radiator Supply
RA-R Radiator Return

1.3 Flat HIU station BE-FNE

FLUSH - MOUNTED

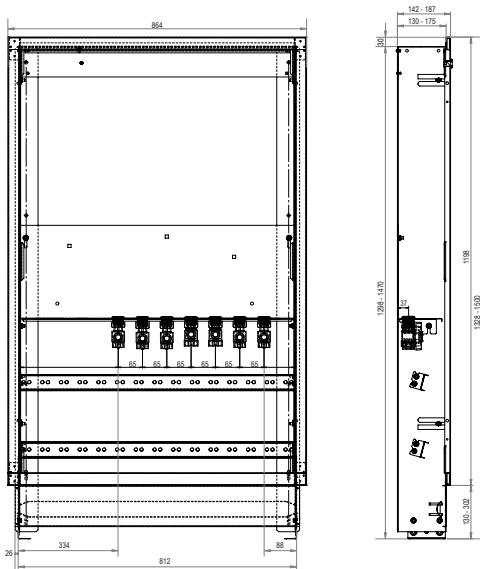

SURFACE - MOUNTED

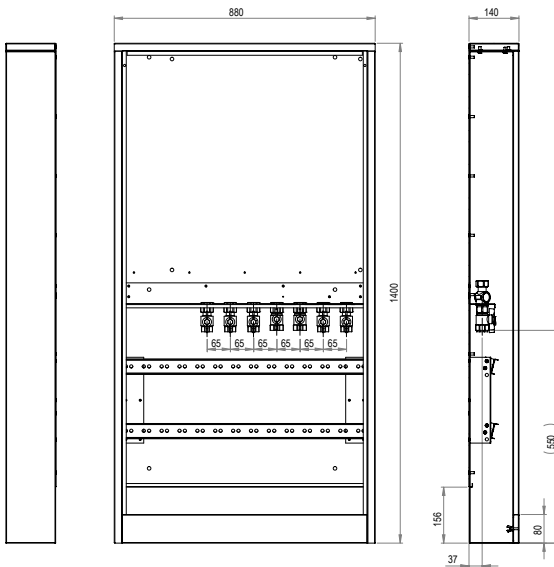

2. Installation



Risk of electric shock

Disconnect the system from the power supply before starting maintenance, servicing and repair work and secure it against being switched back on.



To prevent damage to the system, the installation site must be dry, stable and frost-free.

2.1 Installation: The example of a flush-mounted cabinet



Montagebeispiel

The flat HIU station is designed for flush-mounted or surface-mounted installation.

1. Mark the mounting holes for installing the frame

- Determine the depth according to the product configuration.
- Mark the positions of the mounting holes on the wall and floor.
- Drill the mounting holes for the frame.
- When performing a dry fit, please observe the installation dimensions specified in the product configuration.
- Ensure that the screw connections to the wall and floor are properly secured.
- Drill the holes so that your anchors (plastic expansion anchors, suitable for concrete and solid masonry) can be inserted flush with the holes without any play.
- The diameter and depth of the drill holes depend on the anchor and the wall thickness.

2. Install and secure the frame

- Position the frame against the wall.
- Insert the screws.
- Tighten the mounting screws without applying excessive force until the installation frame is securely in place.
- It is not necessary to remove the base plate.

3. Set aside the frame and the door for final assembly later

4. Connect to the piping system.

- Ensure the correct connection of the primary heating supply and return, the hot and cold water, and the radiator supply and return.
- Refer to the hydraulic diagram for installation guidance.



Improper installation may result in injury!

Connect the hydraulic system correctly and ensure there are no leaks.



To ensure that the flat HIU station functions properly, the power ratings specified in the design must not be reduced!

2. Installation

5. Connect the hydraulic system by following these steps:

A. Prepare the piping

Prepare the piping according to your plan.

B. Install the piping

Install the piping on the flat HIU station according to your plan.

C. Insulate the piping in accordance with national regulations

Insulate the piping with thermal insulation.

The flat HIU station is now hydraulically connected.

6. Final assembly

- Slide the frame with the mounting tabs onto the mounting bolts.
- Tighten the four nuts and install the door.

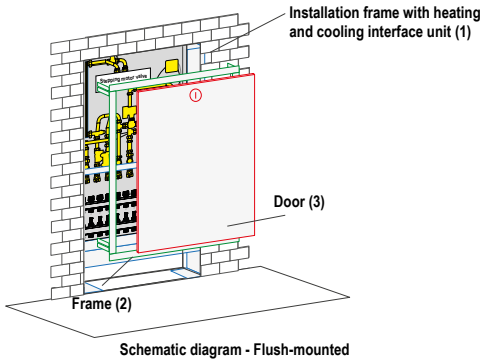

2.2 Making electrical connections



Danger of death from electric shock!

Controllers and pumps are connected to the mains power supply. Contact with live components poses a danger of death.

- When working on electrical components, always disconnect the power supply and secure it against accidental reconnection.
- Work on the electrical system may only be performed by qualified electricians.
- Never touch electrical components with wet or damp parts of your body.
- Never pull on electrical cables.



Property damage due to overheating!

Electrical wiring can be damaged by hot surfaces on components. Route electrical wiring away from components with hot surfaces.

2. Installation



Risk of electric shock

Mains cables (230 V) can interfere with sensor cables (low voltage).
Run mains and sensor cables in separate locations.

The following applies to the electrical connection:

- Have electrical work performed only by qualified personnel.
- Follow the instructions and specifications in the enclosed manual for the respective electronic component.
- Comply with national regulations and guidelines.
- When designing the electrical system, take into account the required protection zone for the installation site.



The flat HIU stations are internally wired and tested to be fully operational in accordance with the scope of the respective order.

The flat HIU stations are connected to a 230 V power supply network using a 3 x 1,5 mm² cable. This cable runs from the fuse box, via a residual current device (RCD) and a 230 V circuit breaker to the flat HIU stations, is inserted into the IPx4-rated power connection box of the flat HIU stations, and is connected there according to the technical specifications (L - brown, N - blue, PE - yellow-green).

2.3 Completing the installation

- Visually inspect all installed components and connections.
- Tighten any loose connections.

The installation of the flat HIU station is now complete.

3. Commissioning



Attention

Property damage due to improper installation!

Improper installation can result in property damage.
Only an authorized professional technician may perform the installation.



Attention

When commissioning the system, please observe the following flushing instructions:

- Before filling the unit, you must first thoroughly and carefully flush the entire heating system and the apartment's heating system
- Before commissioning, you must check the strainer inserts (optional accessories) and flush/clean them if necessary.
- Check the tightness of the flat-seal connection in flat HIU station. Tighten the connections if necessary. When tightening connections, always secure the opposite side.
- Vent the trapped air in the flat HIU station by opening the fill and drain valve on the plate heat exchanger. Pay attention to the system operating pressure while doing so.

To put the flat HIU unit into service, please follow these steps:

1. Inspect the unit before commissioning
2. Flush
3. Fill
4. Vent
5. Activate the controller
6. Check the settings
7. Complete the commissioning report
8. Hand over the unit to the operator

Steps 1–4 are described in detail below.

3.1 Checking the station before commissioning

Before commissioning, you must perform a visual inspection to ensure that the unit has been installed correctly, as follows:

- Check that any installation debris and dust have been properly removed from the unit.
- Check all pipes and connections on the unit for leaks.
- Check that the electrical connections have been made correctly, that the polarity of the power connection is correct, and that proper grounding is ensured.

If you discover an installation error during the visual inspection, you must temporarily halt commissioning and **correct the error first!**

3. Commissioning

3.2 Filling & Rinsing

To flush the flat HIU station, follow these steps.

1. Fill with heating water.

- Fill the flat HIU station with heating water by opening the ball valves in the primary supply and return lines.

2. Flush the flat HIU station.

- Open the fill and drain valve.
- Let the heating water drain from the flat HIU station into a suitable collection container.



3. Instructions: Flushing and filling the underfloor heating system



1. Close the ball valves.



2. Gently open the fill and drain valves.



3. Connect the hoses.



4. Remove the seal caps and open all flow meters.



5. Open the valve for the circuit to be flushed and close all other valves. Turn on the water supply.



6. Once finished, close the valve and open the next valve at the same time.



7. Stop the water supply. Close the fill and drain valves. Remove the hoses and replace the caps.



8. Open all valves and flow meters. Install the sealing caps and open the ball valves.

3. Commissioning

3.3 Venting

Vent the flat HIU station using the fill and vent valve.

(The fill and vent valve is located at the highest point in the flat HIU station – on the plate heat exchanger).



1. Close the ball valves.



2. Gently open the fill and drain valves.

3.4 Refilling the heating system

Refill the heating water that was removed in the boiler room. Please observe the applicable regulations and standards, such as the Heating System Ordinance and VDI 2035.

Now check the settings and record them in the acceptance report (commissioning).

The station can now be handed over to the operator.

4. Settings

4.1 Preset volume flow for underfloor heating circuit with VA-FBif (optional)

Set the flow rate for each underfloor heating circuit to the value calculated in the design. The flow rate is adjusted by turning the gland on the presettable DN20 valve in the return line (No. 4).

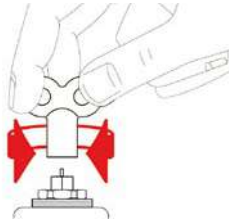

Attention! For flow rates below 1 l/min, we recommend performing the adjustment **ONLY** using Option B—adjustment via the flow meter (see page 26).

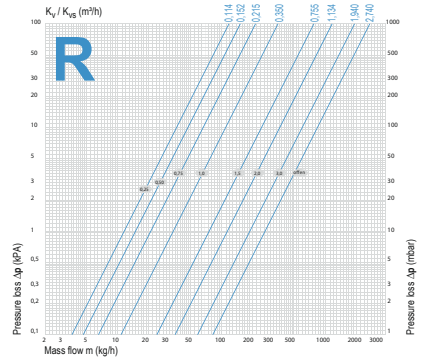

4.2 Setting module D1 - Differential pressure controller

Primary differential pressure regulator (station outlet) for maintaining differential pressure during significant load changes. DN15, continuously adjustable from 20 to 60 kPa, complete with 3 mm connecting capillary tube, Kvs 2.9.

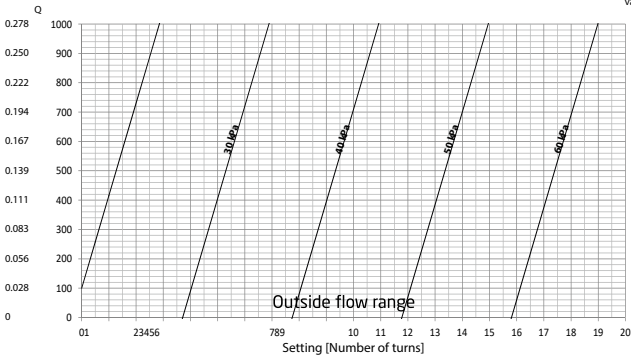

Δp across the valve kPa



(Installation example)

4. Settings

4.3 Settings for the VA-FBif module (optional)

Set the values determined during planning for the hydraulic balancing of the underfloor heating system as described below:

Attention! For flow rates below 1 l/min, we recommend performing the adjustment ONLY using Option B (adjustment via the flow meter).

Option A. Calibration with a reproducible preset

- r1. Remove the sealing cap
- r2. Open the flow meter
- r3. Reinstall the sealing cap
- r4. Open the flow
- r5. Adjust the return valve /
Check the settings on the supply line

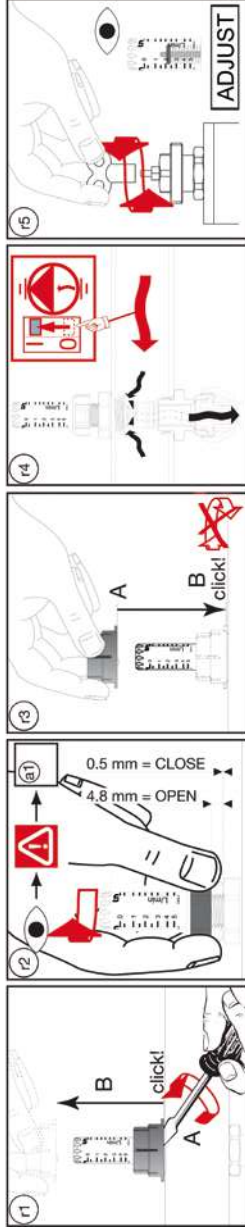

Option B. Adjustment via the flow meter

- r1. Remove the sealing cap
- r2. Open the flow
- r3. Adjust the flow meter
- r4. Check the settings
- r5. Reinstall the sealing cap

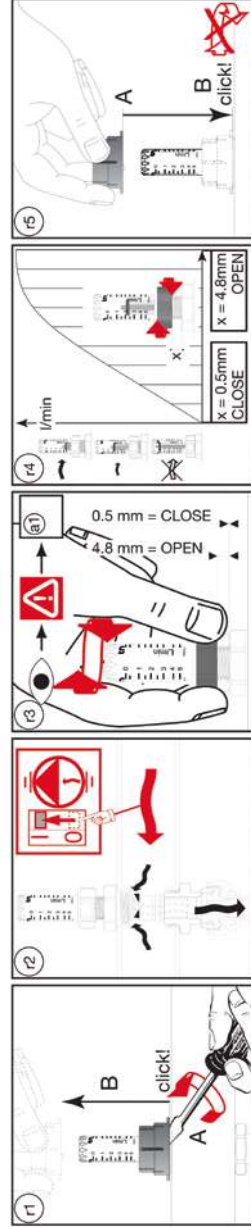

Note: Before setting the system, please bleed and flush the floor heating system as described on page 18-19.

4. Settings

4.4 HCC-Fresh Controller Wiring Diagram

HCC Flat HIU station



Cable color coding:
 ws: white
 br: brown
 gr: grey
 bl: blue
 it: red
 sw: black
 gr/g: green/yellow

Pin Assignment for Controller Board Slots

Slot	Function	Notes
1. CAN/PMU	1. CAN/PMU	1. CAN/PMU
2. CAN/PMU	2. CAN/PMU	2. CAN/PMU
3. CAN/PMU	3. CAN/PMU	3. CAN/PMU
4. CAN/PMU	4. CAN/PMU	4. CAN/PMU
5. CAN/PMU	5. CAN/PMU	5. CAN/PMU
6. CAN/PMU	6. CAN/PMU	6. CAN/PMU
7. CAN/PMU	7. CAN/PMU	7. CAN/PMU
8. CAN/PMU	8. CAN/PMU	8. CAN/PMU
9. CAN/PMU	9. CAN/PMU	9. CAN/PMU
10. CAN/PMU	10. CAN/PMU	10. CAN/PMU

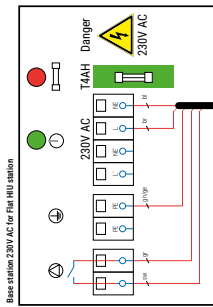
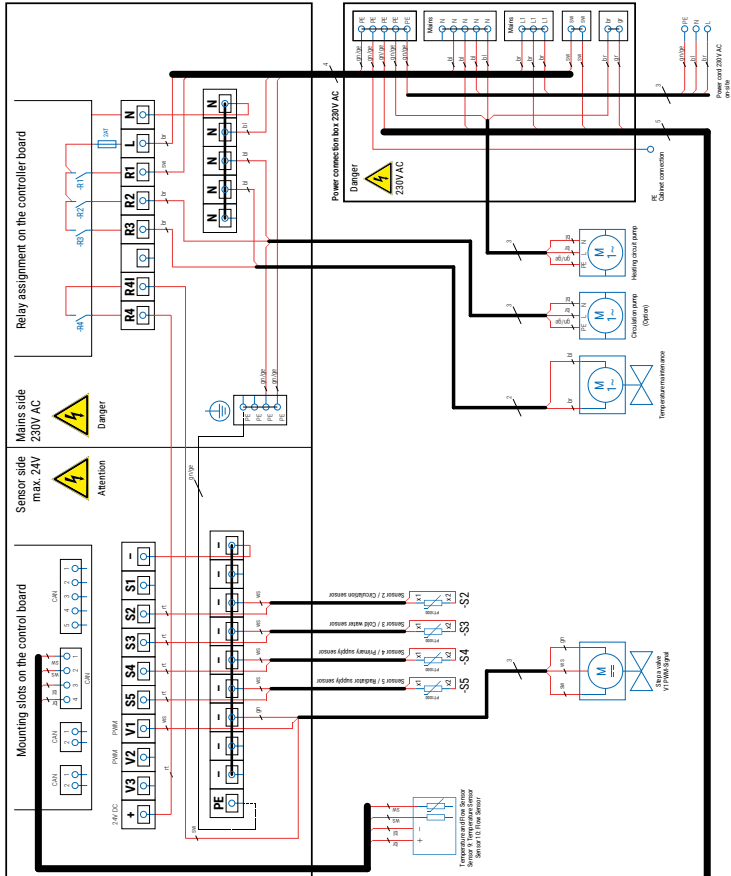

4. Settings

4.5 BE-F Wiring Diagram with Base station and Actuator (Example)

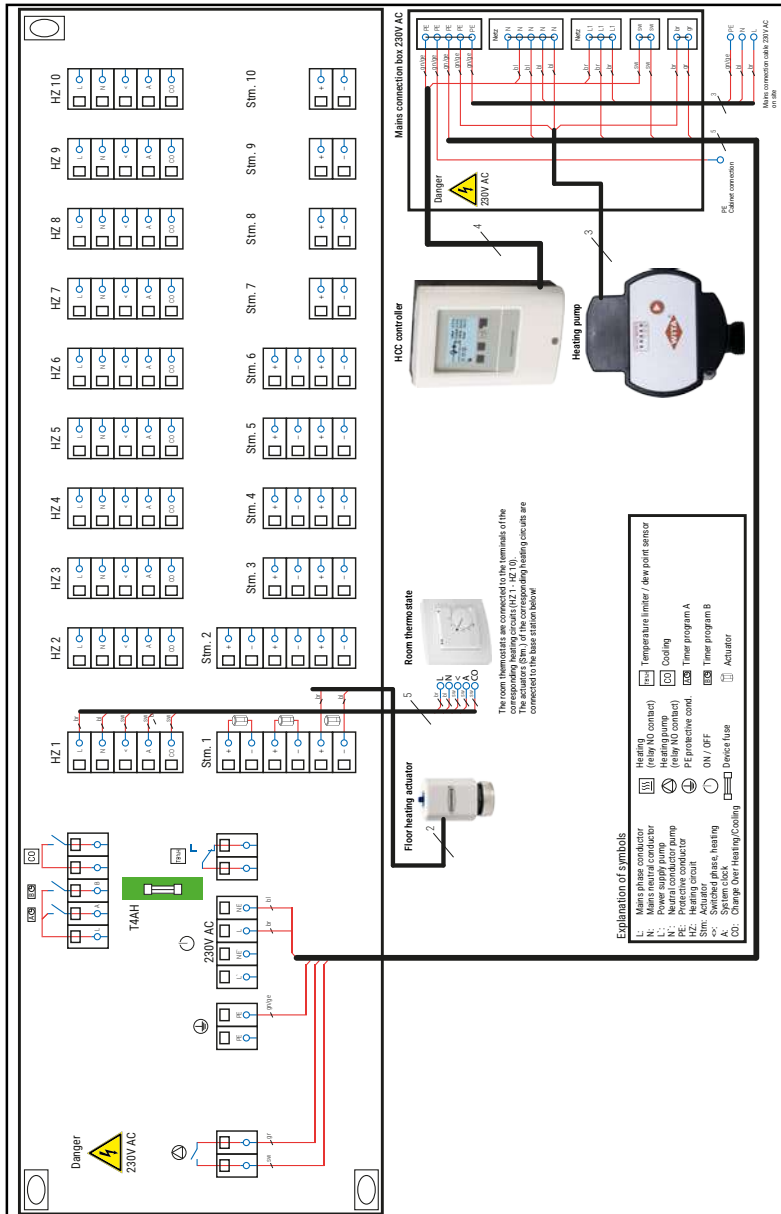

5. Modules

5.1 Module S1 - Strainer insert (optional)

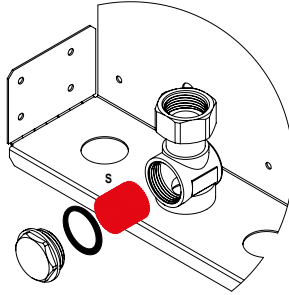
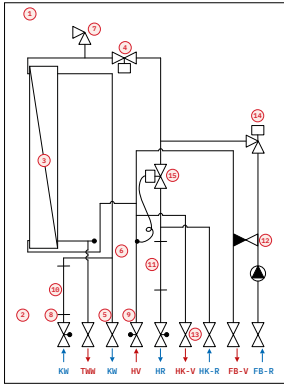

Cleaning the strainer insert:

- Loosen the cap.
- Remove the strainer insert and rinse it under running water.
- Reinsert the strainer insert and reattach the cap.

Strainer insert S1

Can be installed in the following locations: panel heating return UF-R, radiator return RA-R, circulation, cold water (9) and heating supply (10).

5.2 Module ZV - Zone valve (optional)

Zone valve G $\frac{1}{2}$ " with the option to mount an actuator with an M30x1,5 mm thread, installed in the secondary circuit of the radiator.

When an eco-STA 230 V electrothermal actuator is installed, a heating circuit can be controlled via a room thermostat.



5.3 Module VOR - Priority circuit (optional)

Hot water priority circuit for safe and efficient prioritization of hot water production. Integrated into the radiator circuit as a secondary component, it ensures that hot water production takes precedence when there is a simultaneous demand for hot water and heating.



5. Modules

5.4 Module VR - Volume flow controller (optional)

An externally adjustable dynamic flow regulator combined with a differential pressure regulator, installed in the primary return line (station outlet) – with or without a measuring port, DN15, adjustment range up to 1,330 l/h, Kvs 2.7



(Installation example)

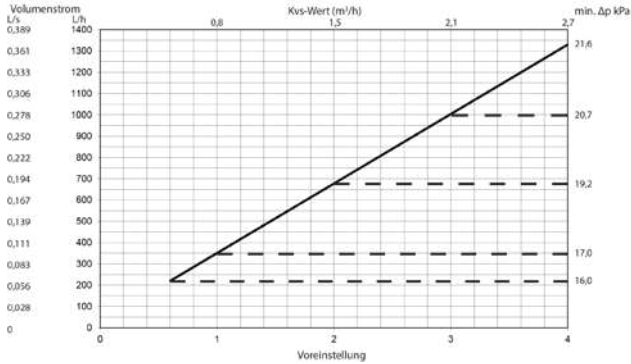

Volume flow presetting (only possible without a pre-installed actuator)

- a) Volume flow range: Low - High
- b) Valve stroke: 2,5 - 4,0 - 5,0 - 5,5 mm



5. Modules

5.5 Module D2 - Differential pressure regulator (optional)

Combi Differential Pressure Regulator - Designed to maintain differential pressure during significant load changes. Continuously adjustable from 20 to 60 kPa, complete with a 3 mm connecting capillary tube.

MEDIA

Medium	Water or water-glycol mixture (up to 50% glycol)
pH value	8 - 9,5

PRESSURE RATINGS

Max. operating pressure max. 16 bar (232 psi)

Pump pressure
 min. $\Delta pc + 10$ kPa
 Q_{max} min: $\Delta pc + 20$ kPa
 Q_{maxH} max: $6 \times \Delta pc$

Default differential pressure setting, range 20 - 60 kPa

OPERATING TEMPERATURES

Maximum operating temperature of the medium -20 to 130 °C



(Installation example)

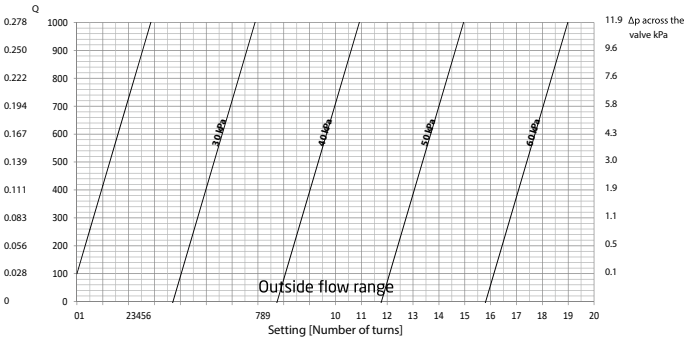

5. Modules

5.6 Other available modules (optional)



Floor manifold VA-FBif

For 2-12 circuits

Set consisting of supply and return bars, each with a G½" fill and drain valve. Soundproofed installation, with labeling stickers and adjustment instructions.



Electrothermal actuator 230 V

For controlling the floor heating circuits at the manifold.

▲ Note: Have us complete the wiring for the station to avoid self-assembly and missing components. Custom designs available on request.



Base station TT-KL6 / TT-KL10

Base station for regulating the temperature for 6 or 10 zones. Connection for up to 15 or 18 actuators and 6 or 10 room control units. Ideal for the central control of complex heating systems.



6. Additional information / 7. Malfunction / Causes / Remedy

6. Additional information

The flat HIU station contains two adapters for an optional heat meter and water meter.



If no meters are installed, **these plastic adapters must be replaced with adapters suitable for continuous use** (e.g., made of 1.4401 stainless steel or brass).

The use of ultrasonic flow meters is recommended (they cause less pressure loss than impeller flow meters).

7. Malfunction / Causes / Remedy

MALFUNCTION	POSSIBLE CAUSES	REMEDY
1. UNDERFLOOR HEATING REMAINS COLD	A. Supply temperature too low	Check the setting in the HCC-Fresh controller according to the quick start guide; set the desired supply temperature if necessary. The complete installation and operating instructions can be found on our website
	B. Pump is off	Check whether the pump is on. If not: a. Check the power connection b. Check the wiring at the base station c. Check the settings (see p. 25) d. Check the safety temperature limiter on the underfloor heating
	C. Pump setting is incorrect	Set the pump to constant pressure (see p. 25)
	D. The regulating valve is closed	Open the regulating valve
	E. Air in the system	Flush the floor heating system (see p. 22)
	F. Heating circuits are closed	Check the flow meters; open if necessary; change the preset if necessary (see p. 25)
2. PRIMARY HEATING CIRCUIT NOT FUNCTIONING	A. Supply temperature too low	<ul style="list-style-type: none"> • Increase the supply temperature at the heat source • Check the buffer tank charge
	B. No volume flow or insufficient volume flow at the unit	<ul style="list-style-type: none"> • Check the valve settings in the unit Note: The flow rate must match the design specifications • If necessary, clean the strainer in the primary supply line • Check the heat meter type (Note: min. Qn 1,5 with low pressure losses) • Check the settings of the central heating pump Recommendation: Set to constant volume flow • Open the shut-off valves • If necessary, check the settings and technical parameters of the differential pressure regulator
	C. Air in the system	<ul style="list-style-type: none"> • Release air via the fill and drain valve on the unit Note: The vent is intended only for the unit • Vent the apartment heating circuit at the designated points • Vent the branch • Retrofit a central vent at the heat source • Vent the buffer tank
3. INSUFFICIENT HOT WATER OR WATER AT TOO LOW A TEMPERATURE	A. Supply temperature too low	<ul style="list-style-type: none"> • Increase the supply temperature at the heat source • Check the buffer tank charge
	B. No volume flow or insufficient volume flow at the unit	<ul style="list-style-type: none"> • Check the valve settings in the unit Note: The flow rate must match the design specifications • If necessary, clean the strainer in the primary supply line • Check the heat meter type (Note: min. Qn 1,5 with low pressure losses) • Check the settings of the central heating pump Recommendation: Set to constant volume flow • Open the shut-off valves
	C. Air in the system	<ul style="list-style-type: none"> • Release air via the fill and drain valve on the unit Note: The vent is intended only for the unit • Vent the branch • Retrofit a central vent at the heat source • Vent the buffer tank
4. HOT WATER NOT WORKING	A. Excessive wait times for hot water	<ul style="list-style-type: none"> • Check the temperature setting on the fresh water regulator and increase it if necessary • Install a domestic hot water recirculation system • Check the settings of the central heating pump Recommendation: Set to constant volume flow

8. Resistance table

The following guide is intended to provide an overview of the corrosion resistance of stainless steels and brazing materials in tap water at room temperature. The table lists several important chemical components; however, actual corrosion is a highly complex process influenced by the combined effects of many different factors.

This table therefore represents a considerable simplification and should not be overinterpreted!

Explanations:

- + = Good resistance under normal conditions
- 0 = Corrosion may occur, especially if other factors are rated 0
- = Use not recommended

SUBSTANCES IN WATER	CONCENTRATION (mg/l or ppm)	TIME LIMITS *	STAINL. STEEL AISI 316	STANDARD PLATE HEAT EXCHANGER **	SPECIAL PLATE HEAT EXCHANGER ***
Alkalinity (HCO ₃ ⁻)	< 70	Within 24 hrs	+	0	+
	70-300		+	+	+
	> 300		+	0/+	+
Sulfate (SO ₄ ²⁻)	< 70	No limit	+	+	+
	70-300		+	0/-	+
	> 300		+	+	+
HCO ₃ ⁻ / SO ₄ ²⁻	> 1,0	No limit	+	+	+
	< 1,0		+	0/-	+
Electrical conductivity	< 10 µS/cm	No limit	+	0	+
	70 - 300 µS/cm		+	+	+
	300 - 500 µS/cm		+	0	+
	> 500 µS/cm		+	-	+
pH ^[2]	< 6,0	Within 24 hrs	0	0	+
	6,0 - 7,5		+	0	+
	7,5 - 9,0		+	+	+
	> 9,0		+	0	+
Ammonium (NH ₄ ⁺)	< 2	Within 24 hrs	+	+	+
	2 - 20		+	0	+
	> 20		+	-	+
Chloride (Cl ⁻)	< 100	No limit	+	+	+
	100 - 200		+	+	+
	200 - 300		+	+	+
	> 300		-	0/+	+
Free chlorine (Cl ₂)	< 1	Within 5 hrs	+	+	+
	1 - 5		-	0	+
	> 5		-	0/-	+
Hydrogen sulfide (H ₂ S)	< 0,05	No limit	+	+	+
	> 0,05		+	0/-	+
Frei (aggressiv) Kohlendioxid (CO ₂)	< 5	No limit	+	+	+
	5 - 20		+	0	+
	> 20		+	-	+
Total hardness (°dH)	4,0 - 8,5	No limit	+	+	+
Nitrate ^[1] (NO ₃)	< 100	No limit	+	+	+
	> 100		+	0	+
Iron ^[3] (Fe)	< 0,2	No limit	+	+	+
	> 0,2		+	0	+
Aluminium (Al)	< 0,2	No limit	+	+	+
	> 0,2		+	0	+
Manganese ^[3] (Mn)	< 0,1	No limit	+	+	+
	> 0,1		+	0	+

^[1] Sulfates and nitrates act as inhibitors for pitting corrosion caused by chlorides in pH-neutral environments.

^[2] In general, a low pH value (below 6) increases the risk of corrosion and a high pH value (above 7.5) reduces the risk of corrosion.

^[3] Fe³⁺ and Mn²⁺ are strong oxidizing agents and can increase the risk of localized corrosion in stainless steels.

SiO₂ above 150 ppm increases the risk of calcification.

* Examination time after sample taking

** Standard plate heat exchanger data refer to copper solder joints

*** Special plate heat exchanger data refer to copper-free solder joints

Notes

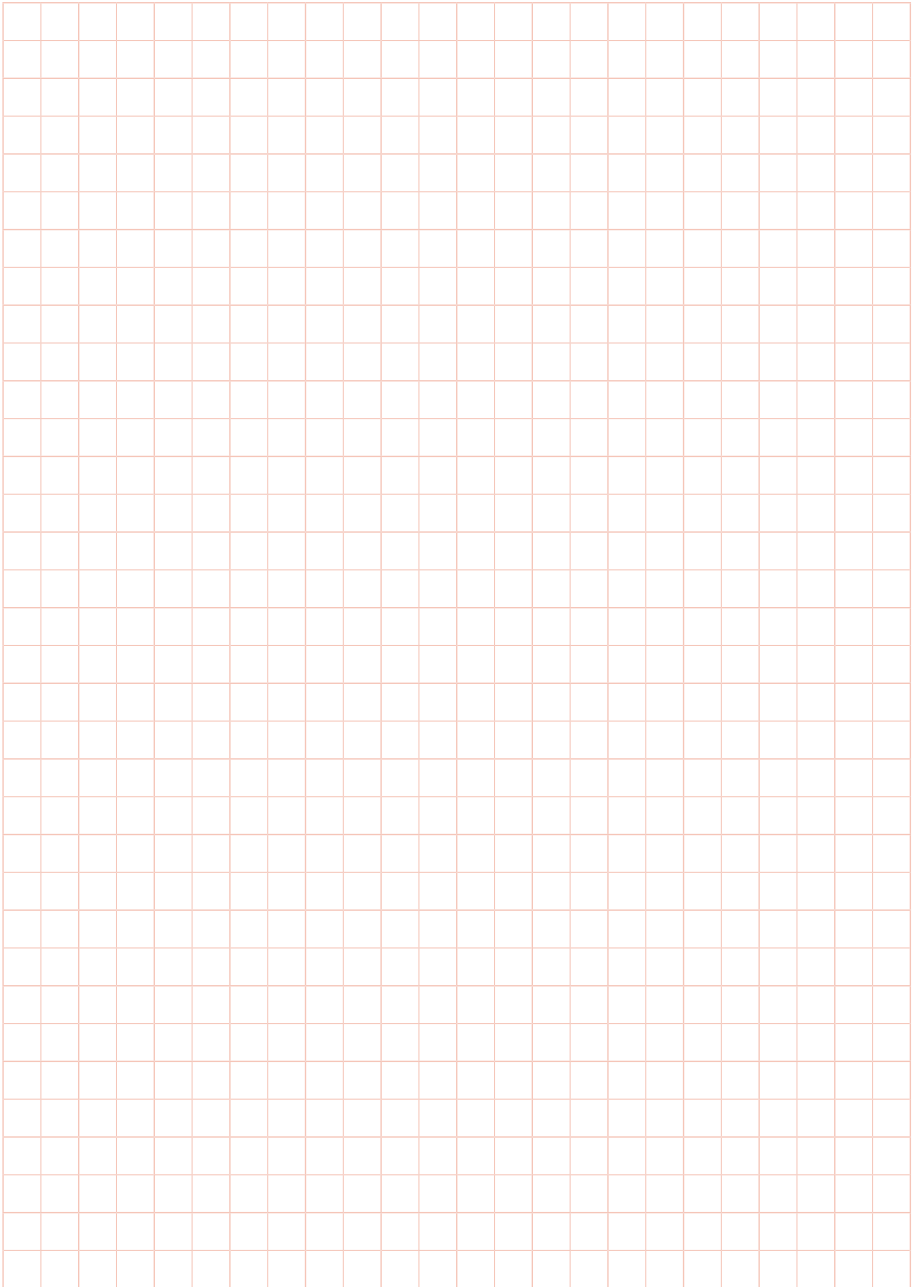

9. Commissioning certificate

COMMISSIONING CERTIFICATE / CERTIFICATE OF GUARANTEE

BUILDING PROJECT		APARTMENT	
Name:	<input type="text"/>	Floor:	<input type="text"/>
Street:	<input type="text"/>	Street:	<input type="text"/>
City:	<input type="text"/>	City:	<input type="text"/>
Project:	<input type="text"/>	Phone:	<input type="text"/>
Order:	<input type="text"/>	Email:	<input type="text"/>
Date:	<input type="text"/>		

PRODUCT			
Type:	<input type="text"/>	FM	SM
		flush-mounted	surface-mounted
Serial number:	<input type="text"/>		M
Manufacturing date:	<input type="text"/>		XL
Number of radiator circuits:	<input type="text"/>		<input type="text"/>
Number of floor circuits:	<input type="text"/>		<input type="text"/>
Test date:	<input type="text"/>	Tester:	<input type="text"/>

To be completed by the customer -----

COMMISSIONING BY (INSTALLER)		COMMISSIONING CHECKLISTE	
Name:	<input type="text"/>	Checking before commissioning:	<input type="checkbox"/>
Street:	<input type="text"/>	Purging:	<input type="checkbox"/>
City:	<input type="text"/>	Filing:	<input type="checkbox"/>
Phone:	<input type="text"/>	Venting:	<input type="checkbox"/>
Email:	<input type="text"/>	Check setting values:	<input type="checkbox"/>
		Completed acceptance report:	<input type="checkbox"/>
		Installed thermostatic sanitary fittings?	YES <input type="checkbox"/> NO <input type="checkbox"/>
		Removed hot water limitation for sanitary fittings?	YES <input type="checkbox"/> NO <input type="checkbox"/>

MEASURED VALUES			
Primary supply temperature:	<input type="text"/>	°C	Temperature maintenance valve:
Primary return temperature:	<input type="text"/>	°C	Sec. differential pressure (module D2):
Hot water temperature:	<input type="text"/>	°C	Floor heating supply temperature:
Hot water amount:	<input type="text"/>	l/min	<input type="text"/>
Primary volume flow for DHW heating:	<input type="text"/>	l/h	

IMPORTANT - PLEASE NOTE!

Commissioning has been carried out correctly.

Please send us the **duly completed acceptance report by email after commissioning**. Only then we can guarantee you adequate support or customer service.

<input type="text"/>	<input type="text"/>	<input type="text"/>
Commissioning date	Customer signature / stamp	Specialist installer signature / stamp
	email to: see back of instruction	

Strasshofer GmbH

Am Fernblick 11
08499 Reichenbach
Germany

Phone: +49 3765 3804 30
E-Mail: info@strasshofer.de

Presented by:

